

CONCEPT 505 DW PROCESSOR

**PRE INSTALLATION
INSTALLATION
USER'S MANUAL**

MACHINE DESCRIPTION:

Manufacturer’s address:3
 Range of application:.....3
 Maximum capacity of the unit:3
 Principle description:3
 Safety Warnings:4

PRE-INSTALLATION:

Technical datas :5
 Crate dimension:5
 Floor space requirement:.....5
 Connections Location :.....6
 Accessories needed for the connections:6

INSTALLATION:

Unpacking:7
 Parts delivered with the machine :8
 Connections:9

USER'S MANUAL:

Initial Operation of the machine:9
 Machine configuration:11
 Value modification:12
 Plate data’s memorisation:13
 Start a Washout cycle :.....13
 Remaining times for plates:14
 Process visualisation:14
 Processing plate after plate:15
 Alarms:16
 To switch off the machine:.....17

Manufacturer's address:**DEGRAF Srl**

"Il Girasole" - Palazzo Donatello 8/03b

20084 Lacchiarella (MI)

Italy

Range of application:

This unit is a part of a full range dedicated for the treatment of flexographic printing plates. This range includes Exposure, Processor, Dryer and light finisher.

The CONCEPT 505 DW PROCESSOR is a unit designed for washout of solvent washable printing plates with dedicated "digital section" to remove the black layer of digital plates.

All the other steps of the process are made with the other equipment of the range.

Maximum capacity of the unit:

	CONCEPT 505 DW PROCESSOR
Number of plates:	3
Minimum plate size:	A4
Maximum plate size:	52 x 80 inches 1320 x 2032 mm

Warning: *This unit is designed to work with solvent and has been tested with conventional product. Always ask your dealer before trying to change the type of solvent. This may result in major damages and safety issues. This machine has not been designed as an explosion proof unit.*

Principle description:

- This unit is designed to wash and clean printing plates after the exposure process.
- The machine is divided in major sections
 - Entrance table and control panel: allow the operator to place the plate on the machine and select the correct parameters to process it.
 - Digital washout section: to remove the black layer of digital plate preventing the contamination of the main washout tank.
 - Washout section: designed to provide high quality and even washout of the plates.
 - Cleaning section: Designed to ensure the cleaning and the wiping of the plate.
 - Exit section.
- The operator interface is made by a touch screen which ensures a very easy interface.

Safety Warnings:

To use this unit safely, it is essential that operators and maintenance people follow the safety instructions and safety precautions and warnings specified in the manuals.

The unit is equipped with emergency switches which allow the operators to stop the machine in case of an emergency.

These emergency switches cut off the power supply of the entire machine.

Make sure that the risk or the problem has been eliminated before restoring the power on the unit.

To release the emergency switches, turn clockwise. The unit has to be re-started following the "Initial Operation"- procedure.

Safety Interlocks

For the safety of operators, interlocks exist for the following:

- Opening of the top covers during operation,*
- Overheating*
- Safety Level Switches*

Technical datas :

CONCEPT 505 DW PROCESSOR	
Dimensions (w x l x h) :	2 080 x 4 570 x 1 000 mm
Net Weight :	1340 Kg
Compressed air supply:	6 bars minimum
Exhaust :	600 m3/h minimum
Power supply :	400V 3Ph / N / PE 50/60Hz 8,5 KW 13 A
	230V 3Ph / PE 50/60Hz 8,5 KW 24 A

Crate dimension:

- Please ensure the handling of the crate will be compatible with the building configuration: doors dimensions, load capacity of the floor ...

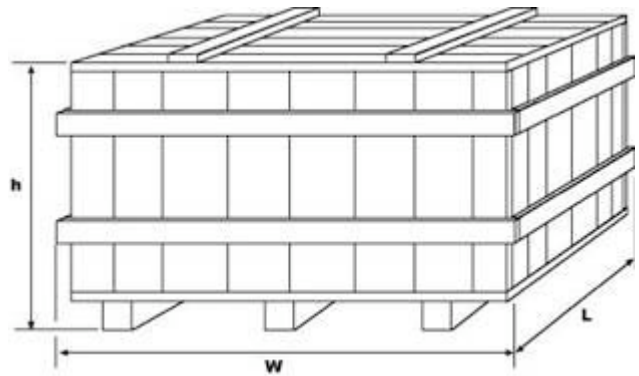

CONCEPT 505 DW PROCESSOR	
W:	2 400 mm.
L:	3 000 mm
H:	2 000 mm.
Weight (crate included):	1 650 Kg

Floor space requirement:

- Please ensure there will be sufficient space around the machine for safe use as well as easy access for maintenance. 1.5 meter free space is needed in front and at the back of the machine to give an easy access. On the sides of the unit 750 mm are requested to allow the access.

Connections Location :

- All the connection points are located on the rear side of the machine.
- The solvent connections are located on the left and the rear side of the unit.
- The compressed air supply connection is located underneath the left side of the exit table.
- The electrical power supply as well as the two connections to the external solvent level sensors are located underneath the right side of the exit table.

Accessories needed for the connections:

Compressed air supply:	6 mm diameter hose
Exhaust :	140 mm. hose
Power supply :	5 x 4mm ² cable for the 400V configuration
	4 x 4mm ² cable for the 230V configuration
Solvent :	Hose, solvent resistant, diameter 20 mm

Upon receipt of your machine please check with the carrier the status of the crate. Notify him of any damage you see on the crate.

Before starting to unpack the unit, make sure you have all required tools ready to hand.

Unpacking:

***Warning:** For safety reasons, please wear appropriate protective clothing (gloves, glasses, and safety shoes) while unpacking.*

- Start by removing the top section of the crate.
- Remove the sides one by one.
- The machine is now resting on the base of the crate.
- Remove all blocking pieces of wood.
- Remove the exit section from the top of the processor.
- Use the appropriate forklift to lift the unit and get it to its installation location. Take care that the forks are long enough to lift the machine without causing damage.
- Put the exit section on the back of the processor.
- Put the transfer chains in place.
- Make the electrical connections in between the two sections.
- Ensure there is sufficient space around the machine (see Pre-installation section).
- Remove all protection from the unit (do not use sharp tools to prevent damages).
- No special anchorage is needed for this unit. The unit will rest only on its feet.
- Align the machine precisely by means of a water gauge. The alignment is made by using the adjustable feet.

Parts delivered with the machine :

Items :	Qty :
Pin bar	2
Hose 140 mm.	3 m.
Locking collars (140mm)	2
Panel key	1
Filter key	1
High level used solvent sensor.	1
Plug and cable for used solvent sensor.	1
Low level fresh solvent sensor.	1
Plug and cable for fresh solvent sensor.	1
Dirty solvent barrel adapter.	1
Fresh solvent barrel adapter.	1
Solvent hoses (16mm diameter) with fittings.	2 x 3 m.
Towel	1
Fixation bar for towel	1
Catch Tray	1
Set of fuses	1
Tube for compressed air	3 m.
Punch device	1
Front cover handle	1
Exit tray	1

Verify that all parts are with the machine.

Connections:

All necessary connections have to be carried out in accordance with the rules and regulations of the installation country.

Electrical connection :

- Connections such as electrical power supply have to be carried out by certified personnel.
- It is recommended to use a ground fault circuit breaker as well as a lockout type power switch for the electrical connection.
- Before switching the machine on, measure the voltage on the main switch of the machine and make sure that it matches the value on the identification plate which is fixed on the back of the unit.

Exhaust blower connection:

- Connect all the exhaust hoses to the appropriate location (directly to the outside or to the building exhaust installation). Ensure the airflow is correct.

Compressed air connection:

- Connect the compressed air line to the unit.

Solvent connection:

- Connect the solvent lines to the correct points.
- Connect the solvent level sensors (high level used solvent and low level fresh solvent) to the correct plugs.

Filling the heater/cooler tank:

- Open the panel located on the left side of the unit.
- Remove the cover of the heater/cooler tank.
- Prepare 3 litres of a solution based on 70% of de-mineralized water (or distilled water), 30% of ethylene glycol and some drops of algacide (anti-foam action).
- Fill the tank to the maximum.
- After operating the unit for a couple of minutes, it may be necessary to check the level of the heater/cooler tank again and to add solution to reach the correct level.

Note: *This operation has to be made with the machine switched OFF*

WARNING: PRIOR TO USE THE MACHINE IT IS REQUIRED TO CONTROL THE DOCTOR BLADES ON THE WIPING BRUSH AND THE TOP AND BACK CLEANING BRUSH. IT SHOULD BE ADJUSTED TO BE ABOUT 3mm DEEP IN THE BRUSH. NOT DOING THIS MAY DAMAGE THE BRUSH

Initial Operation of the machine:

Before switching the machine on make sure that the working area around the machine is clean and free for easy movement.

Check if there are any leaks of solvent as well as all the needed supplies:

- ✓ Electrical power supply : cable connected and not damaged.
- ✓ Compressed air: filter clean and pressure correct.
- ✓ Exhaust: hose connected and not damaged.

- You are now ready to switch the machine on.
- Turn the main switch of the machine, located at the front of the machine (right side).
- Verify that all emergency stop buttons are released. If not, release them by turning them clockwise.
- Switch On the machine by pressing the ON/OFF button located below the control panel of the machine.
- At the switch ON of the machine different screens can be displayed on the touch screen :

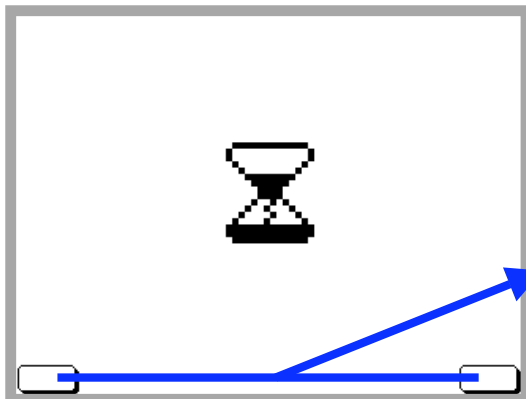

➤ The machine is running an automatic cleaning cycle at the switch ON. This screen disappears as soon as the cleaning cycle is finished.

To cancel the cleaning cycle at the switch ON press simultaneously on the two touches located in the bottom corners.

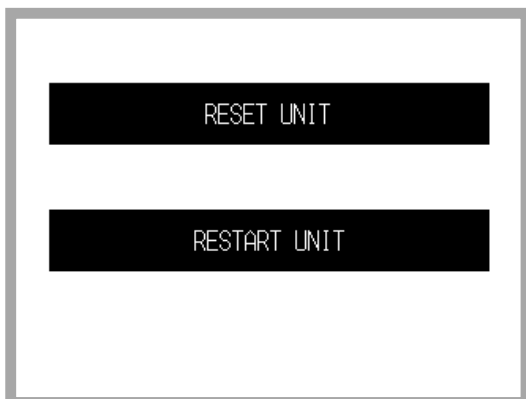

➤ The machine has been stopped with at least 1 plate in process. Keep pressing "RESET UNIT" for few seconds to reset all the on going cycles. Keep pressing "RESTART UNIT" for few seconds to restart the machine at exactly the same status of the power switch OFF. This gives the possibility to continue the process of a plate remaining in the unit.

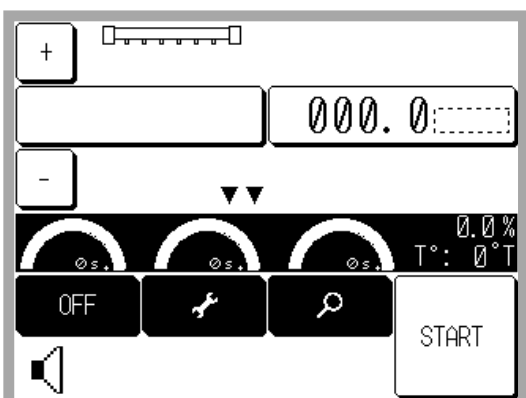

➤ The cleaning cycle has been disabled and the display shows directly the process cycle screen.

Machine configuration:

To access to the machine setup, press on the dedicated touch.

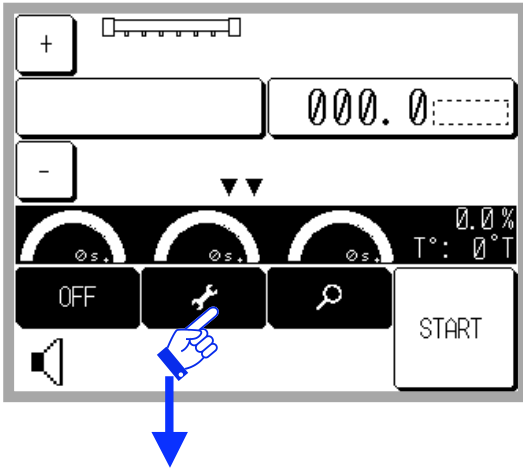

The machine configuration screen allow you to set the machine:

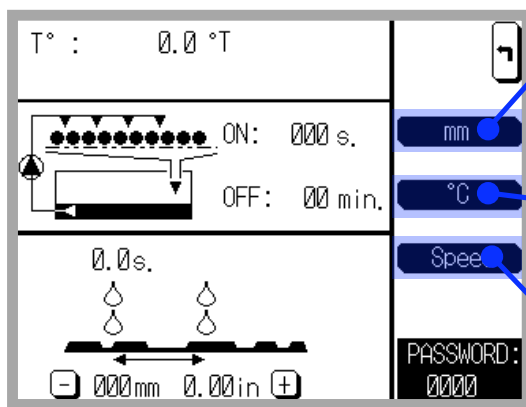

- Set the display of the machine in “mm” or in “inches”. Simply press on the corresponding touch to switch the machine to the desired mode.
- Set the display of the machine in “°C” or in “°F”. Simply press on the corresponding touch to switch the machine to the desired mode.
- Switch the display from the washout speed to the washout time. Press on the touch to switch from one mode to the other.

The machine configuration screen allow you to modify :

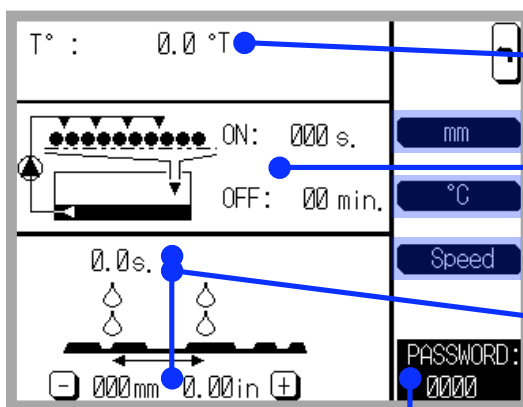

- Set the solvent temperature (displayed in °C or °F).
- The time of the washout solvent circulation as well as the interval time between two circulation.
- The length of the fresh solvent pulses during the cleaning of the plate as well as the distance between these pulses. To modify the distance between the pulses press or . The distance is displayed in both “mm” and “inches”.

Password : used to access to the restricted access screen (refer to “Technical manual”).

Value modification:

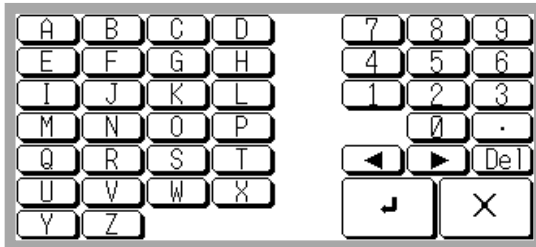

- To change a value (numeric or alpha numeric) press directly on the value desired and the corresponding keypad will appear.

Alpha numeric Keypad:



Numeric keypad:



- Enter the new value and then confirm by pressing on .
- To close the keypad, press on .
- If the value entered is out of the range of the data it comes back automatically to the minimum or maximum range limit. Note these range limits are different for the same data depending on the setup of the machine.



The data's are automatically stored in memory as soon as the touch  is pressed.

Plate data memorisation:

20 memory channels are available to store the plate data.

To switch from one channel to another simply press  or . The memorised data are then displayed.

Parameters are different depending on the configuration of the solid content measuring device (refer to *Technical manual: Solid content measuring device*).

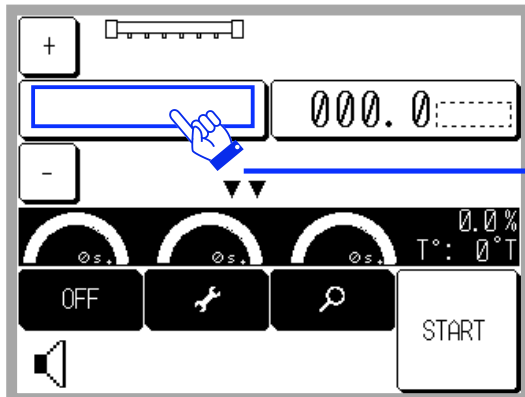

Machine with solid content measurement activated:

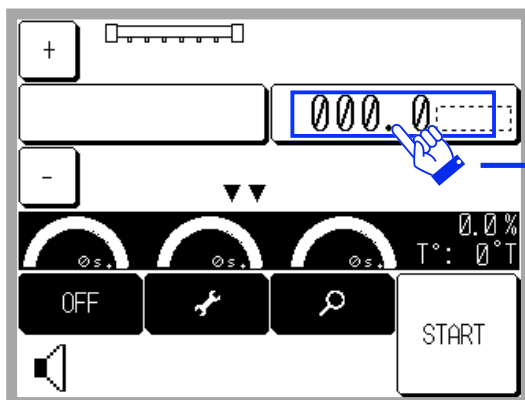

Press this zone to enter the plate type with the alpha numeric keypad.





Press this zone to enter the washout speed with the numeric keypad.

To recall an existing plate type simply press  or .

Note : Depending on the setup of the machine, the washout speed is displayed in mm/min., inches/min. or in time (min).

Start a Washout cycle :

- Select first the program needed by using the touches  or .
- Verify all the parameters are correct.
- Open the entrance cover.
- Place the transport bar on the entrance table and ensure it is well engaged in the locking devices located on each side : must have the 2 "OK" signs on the screen.
- Fix the plate on the middle of the transport bar to allow the plate length sensor (located in the middle of the entrance section) to detect properly the plate.
- Close the entrance cover.
- To start the cycle, press .

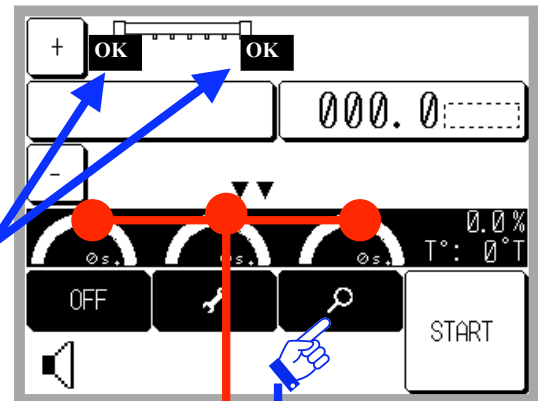

Remaining times for plates:

- 3 bar graphs are available to indicates the process remaining time of each plates.



Note : *The calculation of the remaining time is based on the speed of the change. Times can change quickly if the speed of the chain changes (for example if a second plate is putted in the machine or if the chain switch to high speed for transferring the plate at the end of the exit section after its cleaning).*

Process visualisation:

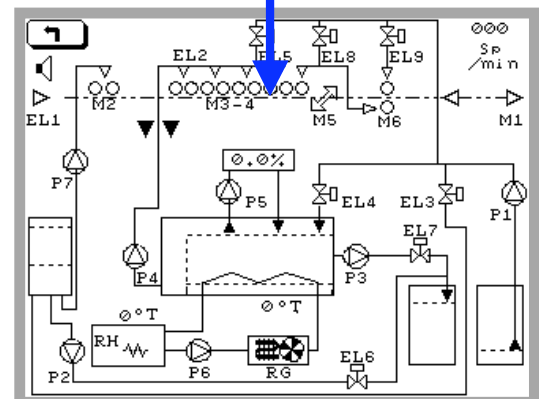
- During the cycle, an action on the dedicated touch switches the display to the dynamic synoptic of the machine.
- All functions running are coloured in black.



Processing plate after plate:

- It is possible to run several plates in the same time in the machine if the washout speeds are the same. In this case, place the plate on the transport bar on the entrance and press . The machine will automatically feed in the plate as soon as it is possible.
- If the washout speed of the plate is different, place the plate on the transport bar on the entrance and press . The machine will automatically feed in the plate as soon as the previous plate is out of the cleaning section.

Note : *the machine can process a maximum of 3 plates in the same time.*

Note : *The sensor which measure the length of the plate is located on the middle of the unit. Be sure to place the plate in front of this sensor.*

Alarms:

- If an alarm is detected an intermittent sound as well as a specific alarm sign are switch ON
- To know which alarm is ON press on the alarm sign to switch to the dynamic synoptic screen.
- It is possible to stop the buzzer by pressing on . The buzzer will automatically restart if an other alarm occurs.

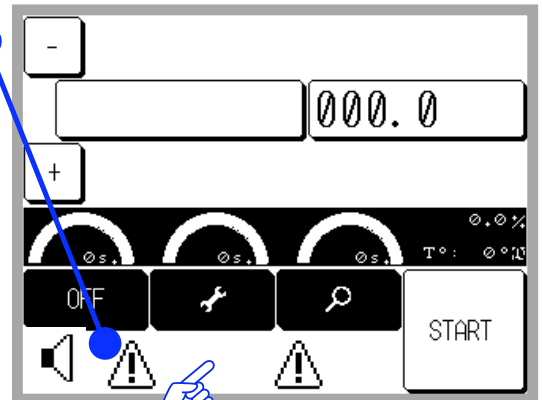

- A graphic alarm sign indicates the type of alarm (refer to following examples) :

- Levels problem for the different solvent tanks. The warning sign is blinking nearby the corresponding level alarm.
- Too high temperature for the solvent or the water). The warning sign is blinking nearby the solvent temperature or the water temperature.
- Problem on a circuit breaker for the pumps and motors. The warning sign is blinking nearby the motor or the pump concerned by the circuit breaker tripped off.

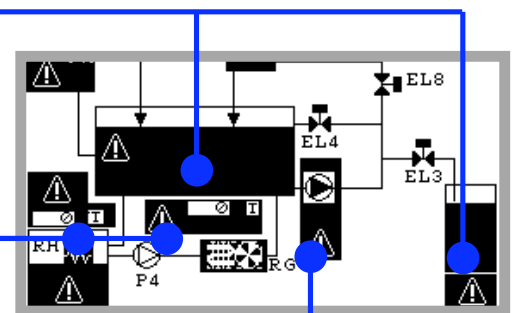

To switch off the machine:

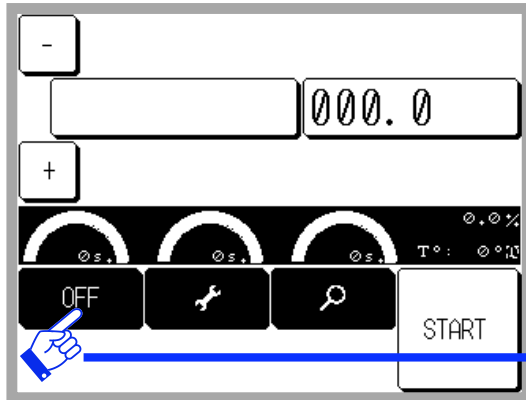

In order to allow the machine to perform the cleaning cycle when the machine is switched off, please use the “OFF” touch located on the main screen.

Keep pressed this touch for few seconds in order to start the cleaning cycle. At its end the machine will automatically switch off.

The cleaning cycle performs the cleaning of all the brushes using fresh solvent (refer to the “*Technical Manual: Machine setup*”).

*Eng Version 2.0: 17/12/2007
Machine V2*